

Packed with Features to Ensure Accuracy in Battery Measurements

- Circuit design friendly for impedance measurements that minimize errors between channels (Effect: 0.01% f.s.*)
- For OCV measurement, internal resistance measurement, and external potential measurement of battery cells
- Measure battery modules up to 60 V DC
- Switch between voltmeter and battery tester while testing
- Built-in short-circuit protection fuse for each channel

Multi-channel Battery Testing

Combine the SW1001 or SW1002 with a battery testing instrument to measure a battery cell's OCV (open circuit voltage), internal resistance, reaction resistance at low frequency, Cole-Cole plot, and external potential on multiple channels.

SW1001



3 Slots

2-wire: 66 channels; 4-wire: 33 channels;
4-terminal pair: 18 channels
(Max. number of channels)

SW1002



12 Slots

2-wire: 264 channels; 4-wire: 132 channels;
4-terminal pair: 72 channels
(Max. number of channels)

OCV Measurements

High-precision OCV measurements

PRECISION DC VOLTMETER DM7276



Internal Resistance Measurements

1 kHz high-speed, high-precision internal resistance measurements
Module weld resistance measurements

BATTERY TESTER BT3562A



Impedance Measurements

Reaction resistance and electrolyte resistance measurements
Cole-Cole plots

BATTERY IMPEDANCE METER BT4560



CHEMICAL IMPEDANCE ANALYZER IM3590



External Potential Measurement

Highly reliable measurement of external potential between electrode and case, using the contact check function

PRECISION DC VOLTMETER DM7276

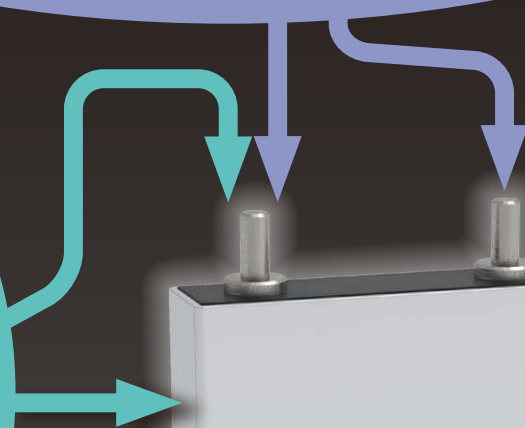

Connect Up to Two Measuring Instruments with Different Functions

Switch between two types of measuring instruments to perform a variety of measurements.*

Configuration Example

Switch between PRECISION DC VOLTMETER DM7276 and BATTERY IMPEDANCE METER BT4560

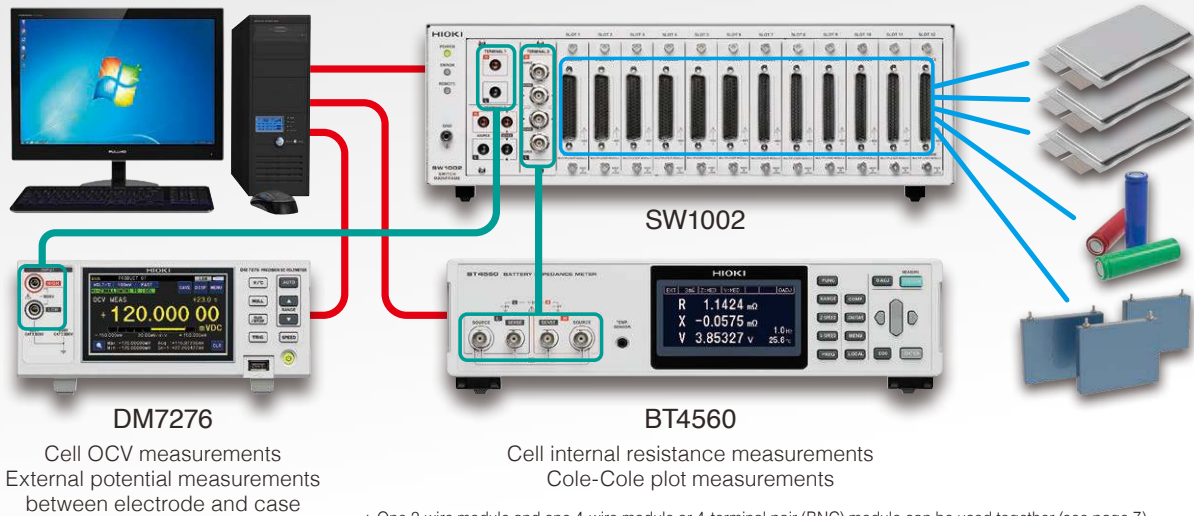

* One 2-wire module and one 4-wire module or 4-terminal pair (BNC) module can be used together (see page 7).
Only one channel can be measured at a time. Two modules cannot be used at the same time to measure multiple channels.

Battery Measurement Supported by Exclusive PC Application

Use the free, downloadable PC application to perform various measurements easily.*

OCV Measurement function

CH	V [V]	V 1st data [V]	dV [mV]	dV [mV/day]	dV/Last 1hr [mV/hr]
1	+03.782915E+00	3.782930	-0.015	-28.799	-1.201
2	+03.782915E+00	3.782932	-0.017	-32.638	-1.361

Enjoy basic functions as well as a newly added dedicated OCV measurement function. This allows you to measure initial voltage, voltage drops, voltage drop rate (mV/day), and the latest voltage drop rate (mV/hour) in addition to OCV measurement values.

A judgment function is also included, making it easy to determine which battery cell is experiencing aging defects.

Logging function

CH1:	CH2:	CH3:
R 1.3202E-003 Ω	R 1.3137E-003 Ω	R 1.3171E-003 Ω
V 3.73378E+000 V	V 3.72289E+000 V	V 3.72855E+000 V
CH4:	CH5:	CH6:
R 1.2819E-003 Ω	R 1.3139E-003 Ω	R 1.2788E-003 Ω
V 3.68999E+000 V	V 3.72332E+000 V	V 3.66479E+000 V
CH7:	CH8:	CH9:
R 1.2821E-003 Ω	R 1.2757E-003 Ω	R 1.2790E-003 Ω
V 3.67032E+000 V	V 3.65953E+000 V	V 3.66509E+000 V
CH10:	CH11:	CH12:
R 1.2725E-003 Ω	R 1.2759E-003 Ω	R 1.3294E-003 Ω
V 3.65429E+000 V	V 3.65988E+000 V	V 3.74906E+000 V
CH13:	CH14:	CH15:
R 1.2727E-003 Ω	R 1.2978E-003 Ω	R 1.3298E-003 Ω
V 3.65482E+000 V	V 3.69607E+000 V	V 3.74939E+000 V
CH16:	CH17:	CH18:
R 1.2945E-003 Ω	R 1.2978E-003 Ω	R 1.2913E-003 Ω
V 3.65083E+000 V	V 3.69640E+000 V	V 3.68560E+000 V
CH19:	CH20:	CH21:
R 1.2947E-003 Ω	R 1.2882E-003 Ω	R 1.2915E-003 Ω
V 3.69116E+000 V	V 3.68037E+000 V	V 3.68593E+000 V
CH22:		
R 1.2850E-003 Ω		
V 3.67517E+000 V		

Multi-channel Cole-Cole plot measurements



Use in combination with supported measurement instruments to perform logging measurements (Interval setting: 1 second to 60 minutes) for up to 264 channels. The judgment function makes it easy to determine the channel on which an abnormality occurred.

Use in combination with the BT4560 or the IM3590 to perform multi-channel Cole-Cole plot measurements.

Allows testing to be performed efficiently for R&D and quality assurance.

*Measurement control supported measuring instruments: DM7275, DM7276, BT3561A, BT3562A, BT3563A, BT3562, BT3563, 3561, BT4560, IM3590, RM3545, RM3544-01
*Save measurement data in CSV file format. *Create save files for each channel. *RS-232C/USB/LAN supported (matching the communication function of the connected device).

LabVIEW® Compatibility

Build a measurement system with your LabVIEW® software and our LabVIEW® driver.*

Download the LabVIEW® driver from the HIOKI website at www.hioki.com.

*LabVIEW® is a trademark of National Instruments Corporation.

HIOKI products compatible with LabVIEW drivers (As of October 2019)			
SW1001, SW1002	OK	DM7275, DM7276	OK
BT3561A, BT3562A, BT3563A	OK	3561	NG
BT4560	OK	IM3590	OK
RM3545	OK	RM3544-01	OK

Circuit Design for Impedance Measurements

The effect on the detection signal is reduced by canceling the magnetic flux of the AC measurement current and separating the source from the sense.

Issue Effect of magnetic flux on 4-terminal measurement

(1) The magnetic flux generated by the measurement current generates induced voltage in the voltage terminal.

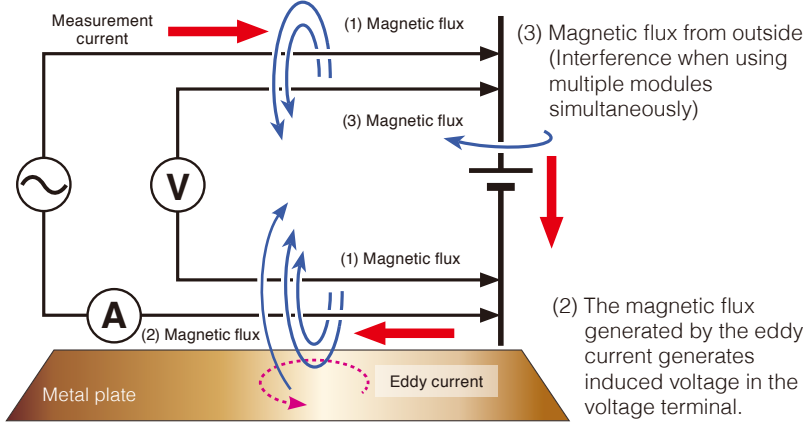

With the 4-terminal method, magnetic flux is generated from the AC measurement current. Further, the magnetic flux generates an eddy current in the surrounding metal, and the magnetic flux from that eddy current affects the detection signal, resulting in errors in measurement values.

Circuit Design for Problem Solving

Multiplexer module circuitry that is not easily affected by eddy currents and noise

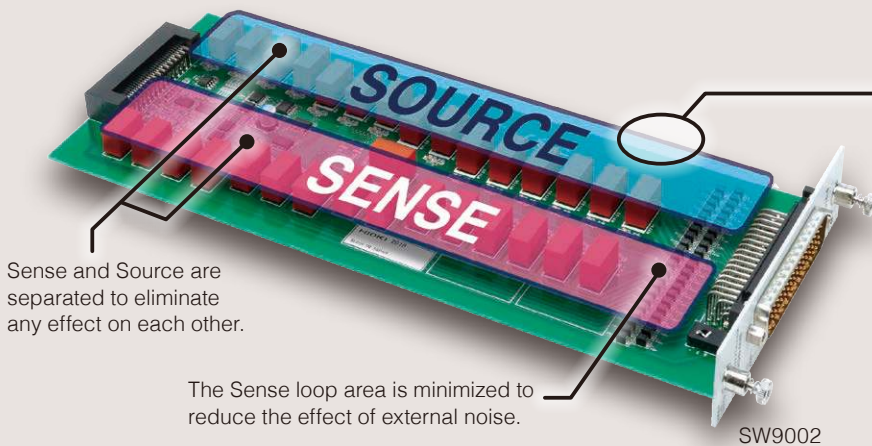

Cross Sectional Image of Substrate

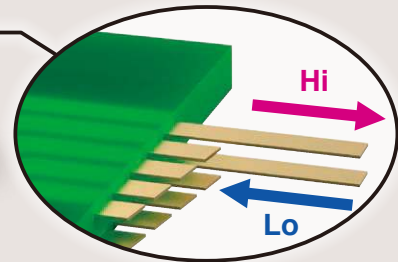

Magnetic flux is canceled by orienting the High/Low patterns on the Source (measurement current) side so that they oppose each other.

Error in Measurement Values between Channels/Slots Due to Use of Switching System

Example of measurement with BT3562A

Measurement conditions: 3 mΩ range, 0 Ω measurement, after zero adjustment by direct connection

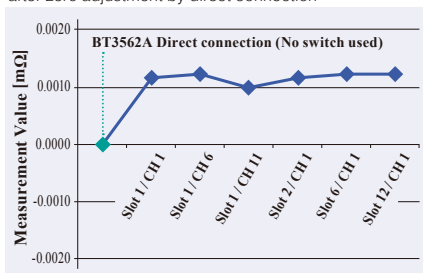

Example of measurement with BT4560

Measurement conditions: RX function, 3 mΩ range, 1 kHz, 0 Ω measurement, after zero adjustment by direct connection

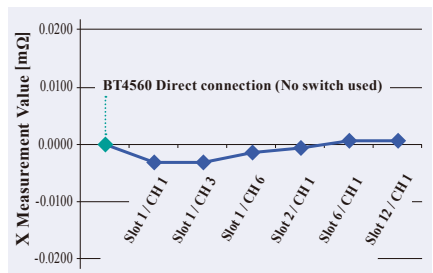
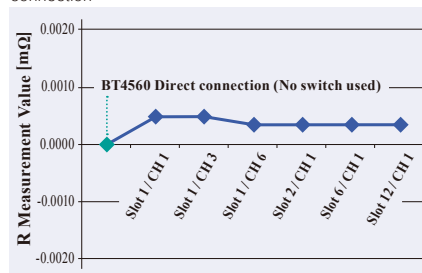

From the measurement results ...

- Little error between when a switch is used or not used. (direct connection of measurement instrument)
- Little error between channels.
- Little error between slots.

Reliable measurement with little effect from eddy currents

Example of Connection Cables and Supported Measurement Instruments

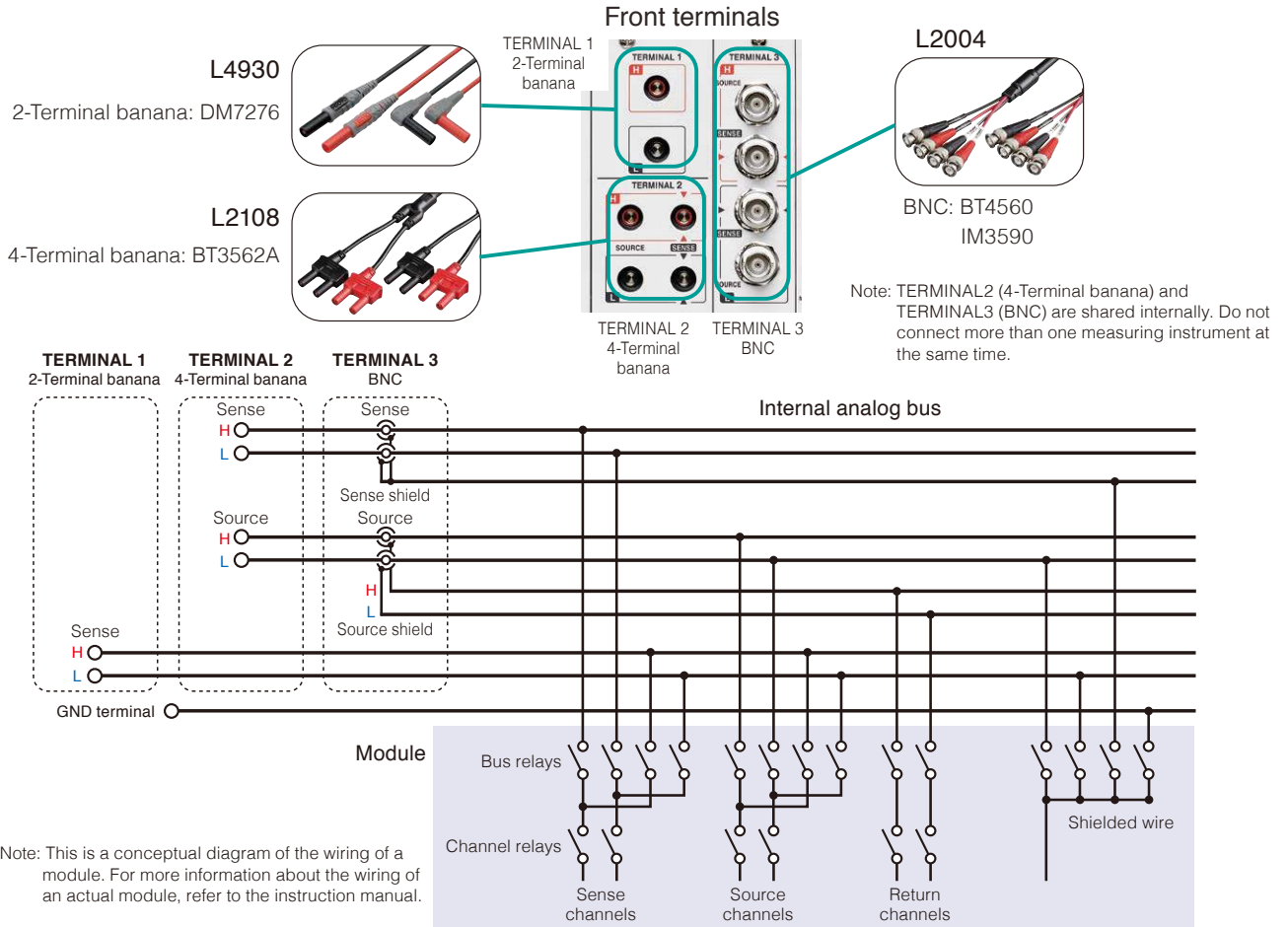

Choose from Two Types of Multiplexer Modules

MULTIPLEXER MODULE SW9001

This module supports 2-wire/4-wire configurations. Channel switching can be performed in 11 ms (excluding communication, command processing time, and contact bounce).



Wiring Method	No. of Channels	Signal Type	Used Signals
2-wire	22	Sense	CH 1 to CH 22
4-wire	11	Source	CH 1 to CH 11
		Sense	CH 12 to CH 22

Example of Connected Measuring Instruments	Terminal	Connection Cable
PRECISION DC VOLTMETER DM7276	TERMINAL 1	L4930
BATTERY HiTESTER BT3562A	TERMINAL 2	L2108

MULTIPLEXER MODULE SW9002

This module supports 4-terminal pair configuration for use in combination with BT4560 and IM3590. 2-wire measurement is also possible (Sense only). Channel switching can be performed in 11 ms (excluding communication, command processing time, and contact bounce).



Wiring Method	No. of Channels	Signal Type	Used Signals
2-wire	6	Sense	Sense CH 1 to CH 6
4-terminal pair	6	Source	Source CH 1 to CH 6
		Return	Return CH 1 to CH 6
		Sense	Sense CH 1 to CH 6

Example of Connected Measurement Instruments	Terminal	Connection Cable
PRECISION DC VOLTMETER DM7276	TERMINAL 1	L4930
BATTERY IMPEDANCE METER BT4560	TERMINAL 3	L2004

Examples of Switching Measurement Time (Use in combination with SW1002 to measure the actual time for scan measurements.)* * Communication with SW1002 via USB.

Module	Measuring Instrument	Function	Measurement Speed	No. of Channels	Delay Time	Scan Time (All Channels)	Conditions
SW9001	DM7276	V	0.02 PLC	22	0 ms	0.45 s (Approx. 20 ms/CH)	Communication with DM7276 via USB Contact check OFF
			FAST	22	0 ms	0.85 s (Approx. 39 ms/CH)	
			MEDIUM	22	0 ms	4.9 s (Approx. 223 ms/CH)	
	BT3562A	Ω V	EX. FAST	11	10 ms	0.45 s (Approx. 41 ms/CH)	Communication with BT3562A via RS-232C (38,400 bps)
MEDIUM			11	10 ms	1.1 s (Approx. 100 ms/CH)		
SW9002	BT4560	RX	FAST	6	0 ms	1.0 s (Approx. 167 ms/CH)	Communication with BT4560 via USB (9600 bps) Measurement frequency: 1 kHz
			MEDIUM	6	0 ms	1.2 s (Approx. 200 ms/CH)	

Connector Pin Layout for Measurement of Multiplexer Module

SW9001 Connector signal table

50-pin D-sub
(Male #4-40 screw UNC)

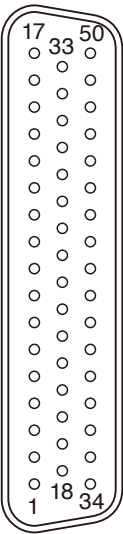

Pin	Signal	Pin	Signal	Pin	Signal
17	Shield	33	CH11 H	50	CH11 L
16	CH10 H	32	CH9 L	49	CH10 L
15	CH9 H	31	CH8 H	48	CH8 L
14	CH7 H	30	CH6 L	47	CH7 L
13	CH6 H	29	CH5 H	46	CH5 L
12	CH4 H	28	CH3 L	45	CH4 L
11	CH3 H	27	CH2 H	44	CH2 L
10	CH1 H	26	Shield	43	CH1 L
9	Shield	25	CH22 H	42	CH22 L
8	CH21 H	24	CH20 L	41	CH21 L
7	CH20 H	23	CH19 H	40	CH19 L
6	CH18 H	22	CH17 L	39	CH18 L
5	CH17 H	21	CH16 H	38	CH16 L
4	CH15 H	20	CH14 L	37	CH15 L
3	CH14 H	19	CH13 H	36	CH13 L
2	CH12 H	18	Shield	35	CH12 L
1	Shield	-	-	34	Shield

With a 4-wire system, channel n and channel n+11 are Source/Sense pairs.

SW9002 Connector signal table

37-pin D-sub
(Male #4-40 screw UNC)

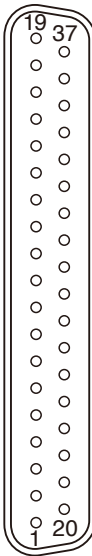

Pin	Signal	Pin	Signal
19	Return CH6 L	37	Source CH6 L
18	Return CH5 L	36	Source CH5 L
17	Return CH4 L	35	Source CH4 L
16	Return CH3 L	34	Source CH3 L
15	Return CH2 L	33	Source CH2 L
14	Return CH1 L	32	Source CH1 L
13	Source CH1 H	31	Return CH1 H
12	Source CH2 H	30	Return CH2 H
11	Source CH3 H	29	Return CH3 H
10	Source CH4 H	28	Return CH4 H
9	Source CH5 H	27	Return CH5 H
8	Source CH6 H	26	Return CH6 H
7	Shield	25	Sense CH1 L
6	Sense CH1 H	24	Sense CH2 L
5	Sense CH2 H	23	Sense CH3 L
4	Sense CH3 H	22	Sense CH4 L
3	Sense CH4 H	21	Sense CH5 L
2	Sense CH5 H	20	Sense CH6 L
1	Sense CH6 H		

When a 2-wire system is used, only Sense CH1 to CH6 are enabled.

Please prepare measurement cables (multiplexer module - measurement target).
Connectors For SW9001: DD-50SF-N, For SW9002: DC-37SF-N
(Manufactured by Japan Aviation Electronics Industry, Ltd.)

Effects when Used in Combination with a Measurement Instrument

Combined measurement accuracy = Accuracy of measurement instrument + Combined effects

SW9001		
BT3561A, BT3562A, BT3563A, BT3562, BT3563 (connected with L2108)		
Range	Effect	Conditions and Remarks
R 3 mΩ	±0.1% f.s.	-
R 30 mΩ to 300 Ω	±0.03% f.s.	-
R 3000 Ω *1	±3.0% rdg. ±0.03% f.s.	Measurement abnormality detection not possible (BT3562, BT3563)
Entire V range	±5 μV *2	After stabilization of temperature in usage environment Within 1 minute of contact closing
3561 (connected with L2108)		
Range	Effect	Conditions and Remarks
Entire R range	±0.03% f.s.	-
Entire V range	±5 μV *2	After stabilization of temperature in usage environment Within 1 minute of contact closing
DM7275, DM7276 (connected with L4930)		
Range	Effect	Conditions and Remarks
Entire V range	±7 μV *2	After stabilization of temperature in usage environment Within 1 minute of contact closing

SW9002			
BT4560 (connected with L2004)			
Range	Effect		Conditions and Remarks
	Freq. Range 0.1 Hz to 100 Hz	Freq. Range 110 Hz to 1050 Hz	
3 mΩ R	±0.05% f.s.	±0.1% f.s.	-
3 mΩ X	±0.1% f.s.	±1.0% f.s.	-
10 mΩ R	±0.015% f.s.	±0.03% f.s.	-
10 mΩ X	±0.03% f.s.	±0.3% f.s.	-
100 mΩ R	±0.01% f.s.	±0.01% f.s.	-
100 mΩ X	±0.015% f.s.	±0.03% f.s.	-
Entire V range	±5 μV *2		After stabilization of temperature in usage environment Within 1 minute of contact closing
IM3590 *3 (connected with L2004)			
Range	Effect	Conditions and Remarks	
100 mΩ to 10 Ω	IM3590 measurement accuracy ×1	DC, 0.001 Hz to 10.000 kHz	
100 Ω to 10 kΩ	IM3590 measurement accuracy ×3	DC, 0.001 Hz to 10.000 kHz Impedance upper limit 10 kΩ	
DM7275, DM7276 (connected with L4930)			
Range	Effect	Conditions and Remarks	
Entire V range	±7 μV *2	After stabilization of temperature in usage environment Within 1 minute of contact closing	

List of possible combinations when using two measuring instruments together

One 2-wire module + one 4-wire module, or one 2-wire module + one 4-terminal pair module can be used together.

1st Module	2nd Module
DM7275 or DM7276	BT3562A or 3561
	BT4560
	IM3590

Combinations of two 2-wire modules, two 4-wire modules, or one 4-wire module + one 4-terminal pair module are not possible.

*1 Measurement anomaly detection function not available in the 3000 Ω range of the BT3562 and BT3563.

*2 The effect of voltage measurement includes the offset voltage of the basic specifications.

*3 The effect when used in combination with the IM3590 is a reference value. It is not a guaranteed value.

SWITCH MAINFRAME SW1001, SWITCH MAINFRAME SW1002 Specifications*1

Slots	3 slots (SW1001), 12 slots (SW1002)	Functions	Channel switching, wiring method, scan function, communication command transmission, channel delay, shield switching
Supported modules	MULTIPLEXER MODULE SW9001 (2-wire/4-wire) MULTIPLEXER MODULE SW9002 (4-terminal pair)	Display	Power LED, Error LED, Remote LED
Connectible instruments	Max. 2 units 2-wire x 1 + 4-wire x 1, or 2-wire x 1 + 4-terminal pair x 1	Compliance standards	Safety: EN61010, EMC: EN61326 Class A
Analog bus terminal	TERMINAL 1: Banana terminal (2-wire) TERMINAL 2: Banana terminal (4-wire) TERMINAL 3: BNC terminal (4-terminal pair)	Operating temperature and humidity range	0°C to 40°C (32°F to 104°F), 80% RH or less (no condensation)
Maximum input voltage	60 V DC*2, 30 V AC rms, 42.4 V peak	Storage temperature and humidity range	-10°C to 50°C (14°F to 122°F), 80% RH or less (no condensation)
Maximum rated voltage to ground	60 V DC	Operating environment	Indoors, Pollution Degree 2, altitude up to 2000 m (6562.20 ft)
Communication I/F	LAN, USB, RS-232C (for host, for measurement instruments)	Power supply	100 to 240 V AC / 30 VA (50/60 Hz)
EXT. I/O	SCAN input, SCAN_RESET input, CLOSE output (to control scanner)	Dimensions and mass	Approx. 215 mm (8.46 in) W x 132 mm (5.20 in) H x 420 mm (16.54 in) D, Approx. 3.7 kg (130.5 oz) (SW1001) Approx. 430 mm (16.93 in) W x 132 mm (5.20 in) H x 420 mm (16.54 in) D, Approx. 6.0 kg (211.6 oz) (SW1002)
		Accessories	Power cord x 1, instruction manual x 1, usage precautions x 1, USB driver CD x 1

MULTIPLEXER MODULE SW9001 Specifications*1

Wiring method	2-wire or 4-wire
No. of channels	22 channels (2-wire) / 11 channels (4-wire)
Contact method	Armature relays
Channel switching time	11 ms (excluding measurement time)
Max. allowable voltage	60 V DC, 30 V AC rms, 42.4 V peak
Max. allowable current	1 A DC, 1 A AC rms
Max. allowable power	30 W (resistive load)
Maximum rated voltage to ground	60 V DC
Offset voltage*3	5 μV (TERMINAL 1, TERMINAL 2 Sense)
Initial path resistance	Less than 1.5 Ω (when using TERMINAL 1) Less than 0.7 Ω (when using TERMINAL 2, 3)
Insulation resistance	1 GΩ or more between High-Low channels (at 60 V DC)
Contact life (reference value)	No load: 50 million times 30 V capacitive load (1.2 μF + 60 Ω, 500 mA peak): 10 million times
Dimensions and mass	Approx. 25.5 mm (1.00 in) W x 110 mm (4.33 in) H x 257 mm (10.12 in) D, Approx. 210 g (7.4 oz)
Accessories	Instruction manual x 1

*1 Product warranty period: 3 years (excluding relays and fuses)

*3 The offset value is from within 1 minute of closing the channel. This value is also taken when the temperature of the usage environment is sufficiently stable, and when the instrument has acclimated to that temperature.

MULTIPLEXER MODULE SW9002 Specifications*1

Wiring method	4-terminal pair (6-wire) or 2-wire
No. of channels	6 channels (4-terminal pair) / 6 channels (2-wire)
Contact method	Armature relays
Channel switching time	11 ms (excluding measurement time)
Max. allowable voltage	60 V DC, 30 V AC rms, 42.4 V peak
Max. allowable current	1 A DC, 1 A AC rms (Sense) 2 A DC, 2 A AC rms (Source, Return)
Max. allowable power	30 W (resistive load)
Maximum rated voltage to ground	60 V DC
Offset voltage*3	5 μV (TERMINAL 1, TERMINAL 2 Sense)
Initial path resistance	Less than 1.5 Ω (when using TERMINAL 1) Less than 1.0 Ω (when using TERMINAL 2, 3)
Insulation resistance	1 GΩ or more between High-Low channels (at 60 V DC)
Contact life (reference value)	No load: 50 million times
Dimensions and mass	Approx. 25.5 mm (1.00 in) W x 110 mm (4.33 in) H x 257 mm (10.12 in) D, Approx. 196 g (6.9 oz)
Accessories	Instruction manual x 1

*2 Cannot connect to battery packs in excess of 60 V DC.

Lineup



SWITCH MAINFRAME SW1001

Model No. (Order Code) : SW1001



SWITCH MAINFRAME SW1002

Model No. (Order Code) : SW1002

Module not included with the switch mainframe. Modules must be purchased separately.

Optional Modules



MULTIPLEXER MODULE SW9001



MULTIPLEXER MODULE SW9002

Optional Connection Cables



CONNECTION CABLE SET L4930
1.2 m (3.94 ft) length



CONNECTION CABLE L2108 (4-Terminal banana)
0.84 m (2.76 ft) length



CONNECTION CABLE L2004 (BNC)
0.91 m (2.99 ft) length

Optional Interface Cables



RS-232C CABLE 9637
9 to 9-pin cross
1.8 m (5.91 ft) length



LAN CABLE 9642
5 m (16.41 ft) length



USB CABLE L1002(A-B)
1 m (3.28 ft) length

Note: Company names and Product names appearing in this catalog are trademarks or registered trademarks of various companies.

HIOKI
HIOKI E. E. CORPORATION

HEADQUARTERS
81 Koizumi,
Ueda, Nagano 386-1192 Japan
<https://www.hioki.com/>



Scan for all regional contact information

DISTRIBUTED BY